

BK ITALIA

Convertibles

**Trasformabile
BK 507**

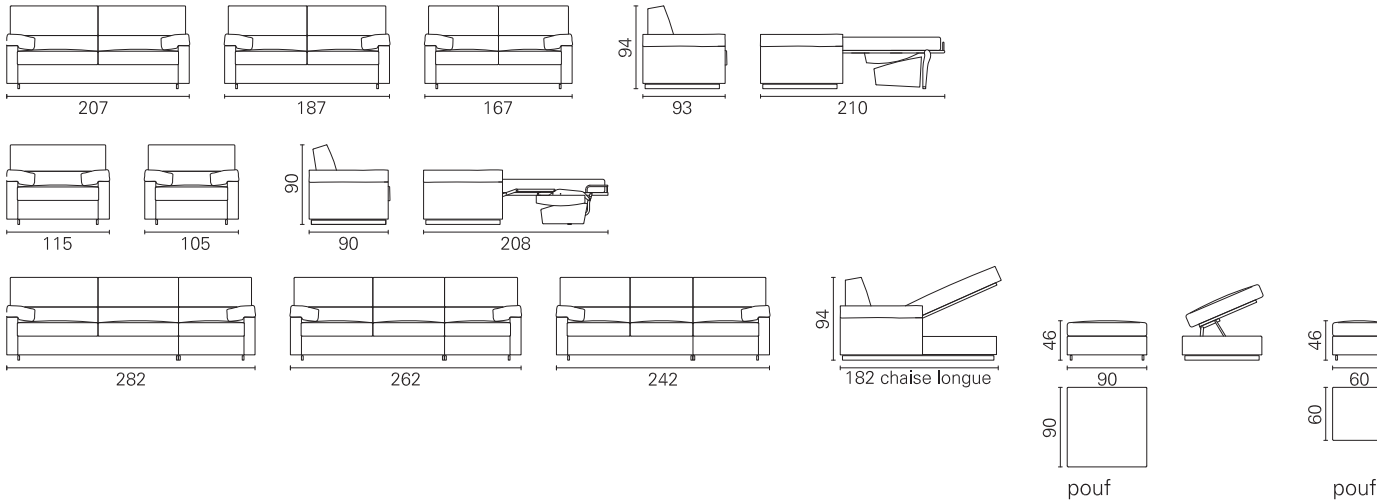



Allestimento standard:

- Divani** - meccanismo Serie 500 - rete a maglia elettrosaldata
- Poltrone** - meccanismo Cube - rete a maglia elettrosaldata
- materasso poliuretano ad elevato confort
- schienale porta guanciali
- sistema di montaggio a baionetta, rivestimento in tessuto sfoderabile

Standard Equipment:

- Sofas** - mechanism Series 500 - weldmesh sleeping deck
- Armchairs** - mechanism Cube - weldmesh sleeping deck
- polyurethane foam mattress - high confort
- back cushions for pillows
- bayonet mount system, removable fabric cover

Opzioni:

- Divani** - meccanismo Serie 500 - rete a doghe
- Poltrone** - meccanismo Cube - rete a doghe
- materassi: molle insacchettate indipendenti, molle insacchettate con lastra in memory, poliuretano con lastra in memory
- topper o copri materasso trapuntato bianco con elastico, lavabile
- guanciale cm. 50x80 bianco
- cuscini d'arredamento in tessuto coordinabile
- chaise longue e pouf con o senza contenitore

Options:

- Sofas** - mechanism Series 500 - slats-frame
- Armchairs** - mechanism Cube - orthopaedic bedstead with slats
- mattress: independent pocket spring mattress, independent pocket spring mattress with memory, memory foam mattress
- topper or bedspread white padded fabric, washable with elastic
- white pillow cm. 50x80
- cushions in coordinabile fabric
- chaise longue and pouf with or without box

BK 507

Misura materasso Mattress size	Misura divano Sofa size
cm 158 x 195	207 - 282
cm 138 x 195	187 - 262
cm 118 x 195	167 - 242
cm 77 x 195	115
cm 67 x 195	105

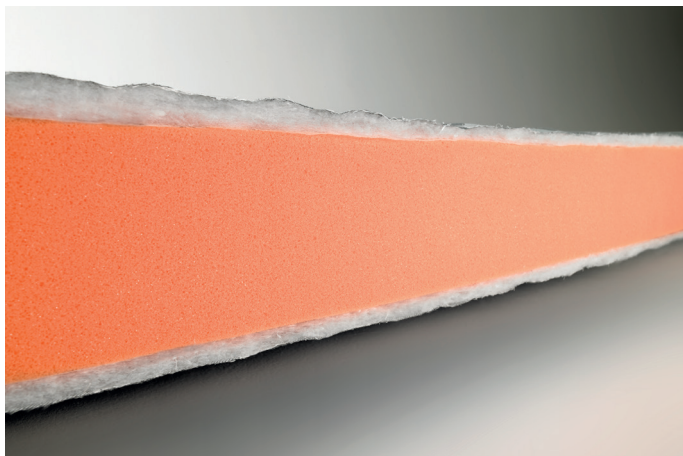

Il materasso in poliuretano ad elevato confort è un ottimo compromesso che combina adattabilità e sostegno.

Caratteristiche e utilizzo: Materasso elastico, con buona adattabilità, consigliato per l'uso quotidiano, per i climi freddi e per chi non ha difficoltà nella regolazione termica (il poliuretano è un ottimo isolante termico). La struttura è costituita da una lastra in poliuretano ad alta densità che garantisce ottimo sostegno ma è al tempo stesso morbida e accogliente.

Materiali: Il materasso è composto da un'anima di poliuretano espanso ignifugo senza C.F.C., indeformabile, rivestito da una falda di fibra termolegata. Il tessuto di rivestimento è in filo di poliestere e fibra modacrilica.

Tutti i materiali sono ignifughi e i materassi sono omologati in classe di reazione al fuoco 1IM secondo le rigide procedure del Ministero degli Interni italiano.

The polyurethane foam mattress - high confort is a good compromise that combines adaptability and support.

Features and use: elastic mattress, with good adaptability, recommended for everyday use, for cold climates and for those who have not difficulty in thermal regulation (polyurethane is an excellent thermal insulator).

The structure is made from a layer of high density polyurethane that ensures good support but at the same time soft and comfortable.

Materials: Polyurethane mattress is made by a polyurethane foam core with no C.F.C., non-deformable, covered with a heat sealed layer. The covering fabric is in polyester and modacrylic fiber. All materials are fire retardant and moreover mattresses are 1 IM fire reaction class in accordance with the strict laws of Italian rules.



Serie 500 maglia elettrosaldata

Sistema con piano del letto ortopedico, con rete elettrosaldata e cinghie elastiche sulla seduta.

500 Series electro-welded mesh

System with orthopedic bed base, with electro-welded mesh and elastic belts on the seat.



Schienale porta guanciali

Back cushions for pillows